

The Scissor Skills Sourcebook



Josiane Caron Santha
Occupational Therapist

Includes:

Complete program
50+ multi-page projects
(color, cut & glue)

Strategies for helping
children with difficulties

Progress certificates,
observation forms and
many other tools

100+ activity ideas
and much more...

Projects Illustrator
Glen Santha



A developmentally based, multi-age, scissor cutting program and resource guide for teaching scissor cutting skills to children

Table of Contents



Section 1: Theory, Advice, Strategies and Tools

Table of Contents	5
Author's Acknowledgements	8
About The Scissor Skills Sourcebook	9
Principles Used in this Sourcebook	11
Where to Start?	12
Understanding Scissor Skills	14
Skill Development	16
Interest Phase (Around 18-24 Months)	17
Experimentation Phase (Around 24 to 36 Months)	18
Improvement Phase (Around 3-7 years old)	20
Gross Motor Activities	22
Fine Motor Activities	25
Promoting Hand Dominance	27
One Cut at a Time.....Let's Have Fun Cutting Things!	29
Scissors	30
Finger Position	30
Strategies	31
Teaching Scissor Grip	31
Teaching the Proper Position of the Hands (Thumbs Up)	32
Teaching to Cut Using the Inside Part of the Blades	33
Teaching Change of Direction	34
Teaching to Isolate the Elements Before Cutting.....	38
Strategies For Small Problems	40



Appendices.....45

Appendix A: Child’s Abilities Observation Form.....46
Appendix B: Child’s Abilities Tracking Sheet.....47
Appendix C: Road With Crocodiles.....48
Appendix D: Visual Sequence Tool.....49
Appendix E: Pictograms For Visual Sequence Tool50
Appendix F: Certificate of Completion for Cutting Lines.....51
Appendix G: Certificate of Completion for Cutting Geometric Shapes52
Appendix H: Certificate of Completion for Cutting Curves & Circles53
Appendix I: Certificate of Completion for Cutting Irregular Shapes.....54

Section 2: The Cutting Program

The Cutting Program56

Which Project Do I Start With? 57
Choose the Difficulty Level 58
Start a Project..... 59

List of Projects60

Cutting Straight Lines.....61

Project 1: The Bag of Candy..... 62
Project 2: The Birthday Party..... 67
Project 3: The Crown 72
Project 4: The Snowflake 77
Project 5: The Apple..... 79
Project 6: The Hairy Head 84
Project 7: The Octopus 88
Project 8: The Sun 92
Project 9: The Train..... 96
Project 10: The Bowl of Fruit..... 100
Project 11: Bracelets 105
Project 12: Garland..... 108
Project 13: The Hedgehog..... 111
Project 14: The Puzzle..... 116
Certificate of Completion for Cutting Lines..... 121





Cutting Geometric Shapes	122
Project 15: The Stop Sign	123
Project 16: The Traffic Light	128
Project 17: The Television	133
Project 18: The Picture Frame	138
Project 19: The Kite	141
Project 20: The Christmas Tree	146
Project 21: The Piano	152
Project 22: The Pyramid	157
Project 23: The Pumpkin.....	162
Project 24: The Robot	166
Project 25: The House	171
Project 26: The Boat	176
Certificate of Completion for Cutting Geometric Shapes.....	181
Cutting Curves and Circles.....	182
Project 27: The Watermelon	183
Project 28: The Igloo.....	188
Project 29: The Rainbow	194
Project 30: The Football.....	200
Project 31: The Moon	205
Project 32: The Mother's Day Card	210
Project 33: Planets.....	215
Project 34: The Pizza.....	220
Project 35: The Meal	225
Project 36: The Clock	230
Project 37: The Snowman.....	236
Project 38: Sports Balls	241
Project 39: The Bear	246
Certificate of Completion for Cutting Curves and Circles	251
Cutting Irregular Shapes	252
Project 40: The Toothbrush and Toothpaste	253
Project 41: The Beverage.....	256
Project 42: The Butterfly.....	260
Project 43: The Ice Cream Cone	265
Project 44: The Car.....	270
Project 45: The Bone.....	273
Project 46: The Storm	277
Project 47: Clothes	282
Project 48: The Flower	290
Project 49: The Cat.....	295
Project 50: Tools.....	300
Certificate of Completion for Cutting Irregular Shapes.....	305

Interest Phase (Around 18-24 Months)



Interest Phase (Around 18-24 Months)

The child notices the scissors with a parent or another older child. They understand that scissors are complementary to paper and are interested in the mechanism. In their first experiments with scissors, the child mostly plays with the tool without putting their fingers in the holes. Scissors usually remain closed and the child uses these mainly for randomly hitting on the paper in an effort to understand how they work. At this stage, the child does not know how to use the tool but is interested by their desire to imitate their parents or older siblings.

The child may not be ready to begin their apprenticeship in cutting. This step is still important to stimulate curiosity and motivation for cutting. Follow this step. Do not push the child to place their fingers in the holes. Ideally, get them a pair of plastic toy scissors (without blades) for their first experiences.

Stimulate the Child to the Interest Phase

- Cut while the child is watching and draw attention to the transformation of the paper.
- Combine words or sounds to bits of paper falling.
- Let them handle a **SAFE** pair of scissors.
- Do activities that promote gross motor development to get their body ready to learn scissors skills.
- Include scissor cutting in symbolic play (e.g. cut Play-Doh bits to feed hungry animal figurines).



Fine Motor Activities



Objectives:

- To strengthen the muscles of the hands.
- To promote the dissociation of the arches of the hand and finger segments.



Ideas:



Yum-Yum:

Carry small objects with food tongs or large claws. Feed the small items to a small animal with an open mouth.



Quick Dry:

Painting construction paper using cotton swabs moistened with water.

Mute, not silent:

Learning some letters in sign language.



Baby Crayons:

Color with small pieces of wax crayon or chalk.

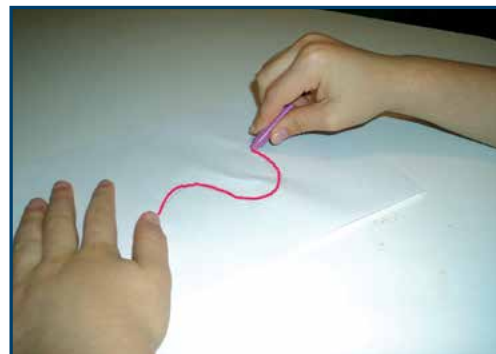

Tug of War:

Play with a towel, washcloth or coffee sticks.



Hurricane:

Spray water at each other with a spray bottle or an empty shampoo bottle.

The Restaurant: Using play-doh or clay, toothpicks, plastic knives, or cookie molds. Making restaurant food by molding the Play-Doh or cutting and poking it with the toothpicks or plastic knives.



Strategies



Teaching Change of Direction

Objective: To teach the child to first identify required changes in direction and then turn the sheet rather than reorienting the scissors.

- 1 Play "The Traffic Game". Make a stop sign and use it for role play where the child pretends to be a car that should stop when it comes to a stop sign.
- 2 Draw a road (or use the form provided on the next page) with enough room to drive a toy car. Put a stop sign in each corner and practice to stop and turn the car.
- 3 Then help the child imagine what would happen if we could turn the road rather than the car ... by driving the car to the corner, the car is immobilized while the other hand turns the road. It often helps to add a sound to this action (a CORNER..... "STOP!"turn the road..... "BJJJJJJJ" keep driving).

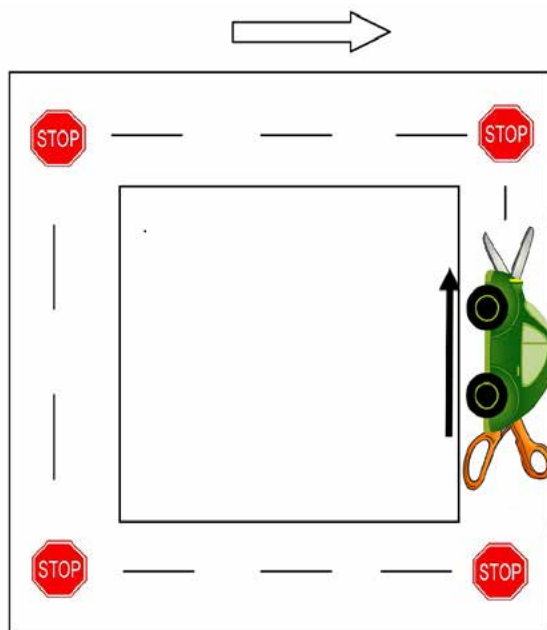

- 4 Once the child masters this manoeuvre, take the scissors and encourage the child to imagine that the scissors are the car. Starting with a square of medium size (if the square is too big it will be more difficult to handle), the child practices to stop at the corner and turn the paper. To make the activity more concrete and fun, kids will love it if you cut the small car found on page 36 and paste it with an adhesive piece of paper on the side of their scissors.

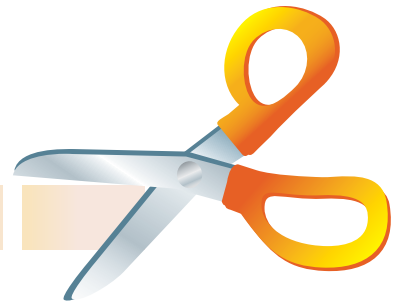

Appendix: Plot for changes in direction

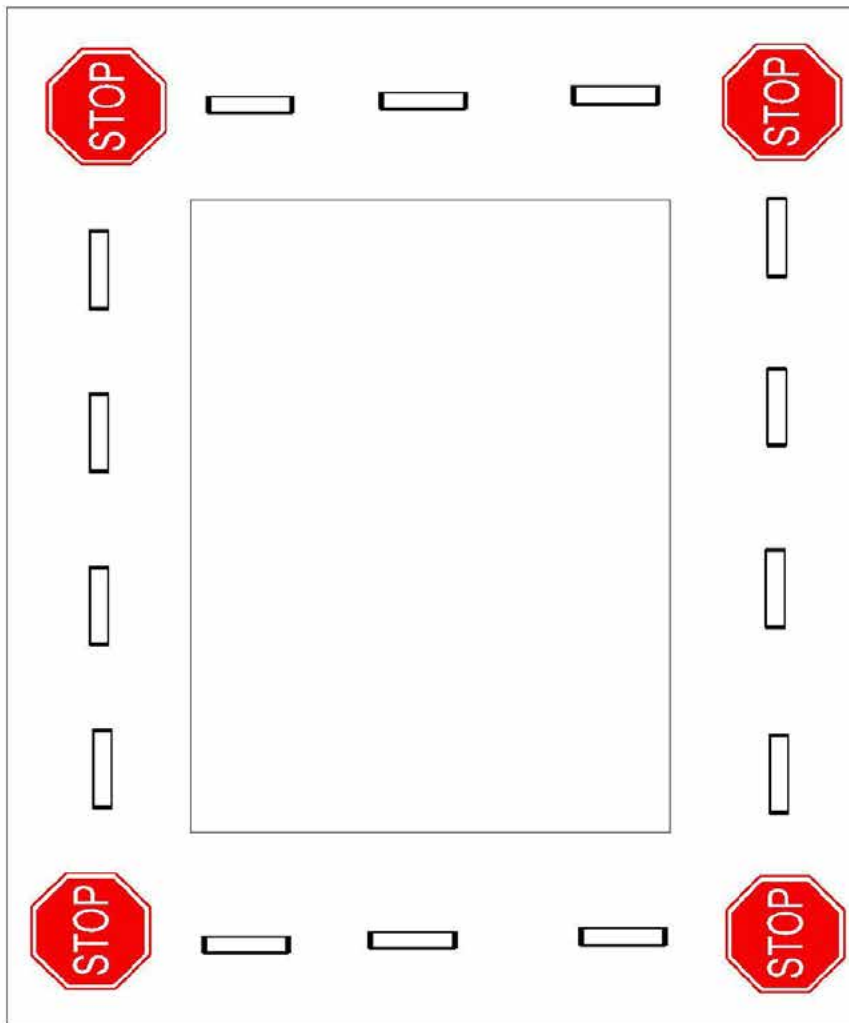

Child's Name: _____ Age: _____



The Scissor Skills Sourcebook: Child's Abilities Observation Form

Project: _____ Date: _____

Motor Skills	
a) Sitting Posture	
b) Scissor Grasp	
c) Position of Arms While Cutting	
d) Bilateral Hand Coordination	
Cutting Skills	
e) Type of Shapes Cut <i>(According to Age Expectations)</i>	
f) Control of Scissor Range Opening <i>(According to Shape)</i>	
g) Control of Paper Position Between the Blades <i>(Proximal Versus Point)</i>	
h) Change of Direction Control Management	
i) Cutting Rhythm and Fluidity	
j) Cutting Precision	
k) Quality / Speed Relationship	
Supporting Skills	
l) Use of Strategies	
m) Overall Task Organization	
n) Autonomy to Complete Entire Project	

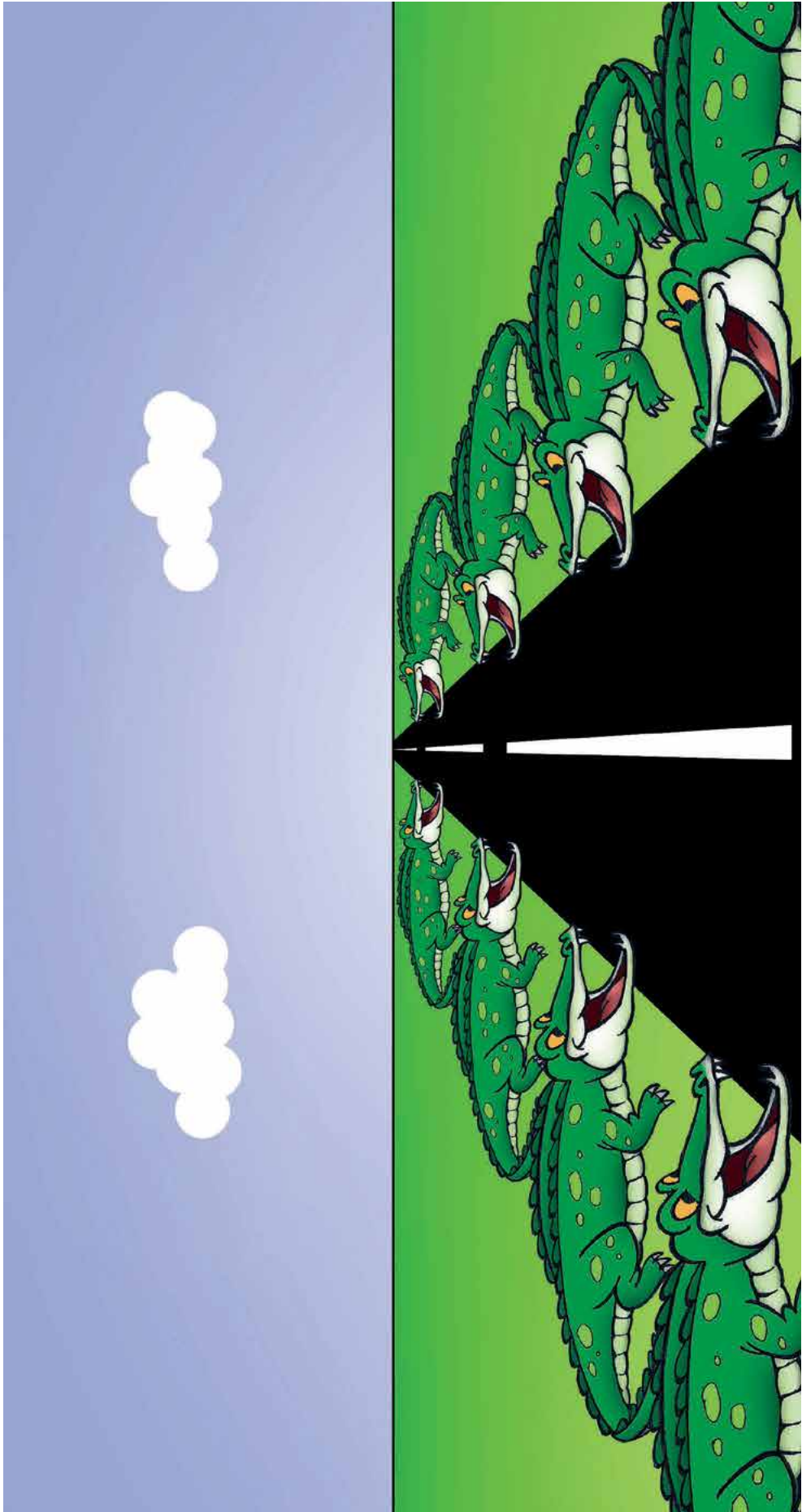

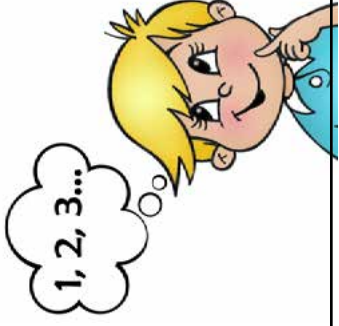

MY PROJECT SEQUENCE

1						
2						
3						
4						
5						
6						

PICTOGRAMS TO REPRODUCE AND PLASTIFY

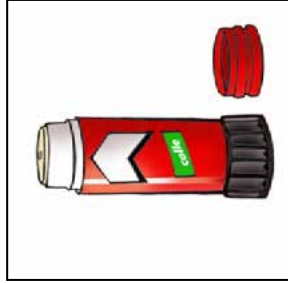

Glue

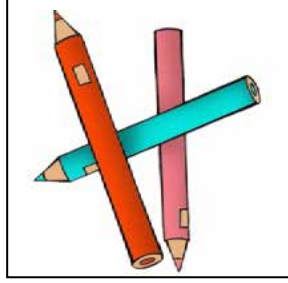

Color

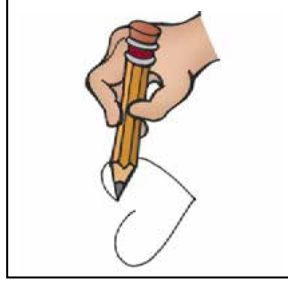

Trace or draw.

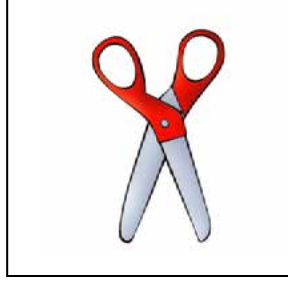

Cut

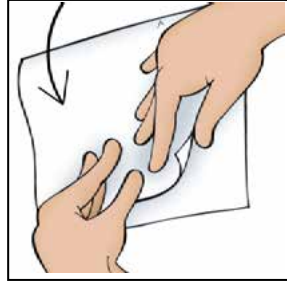

Fold

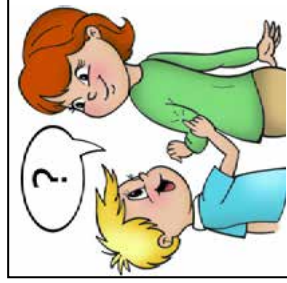

Ask for help.

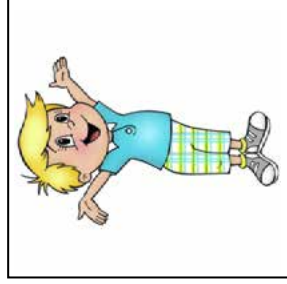

Done - proud of myself.



Closing pictogram for projects with less than 6 steps.

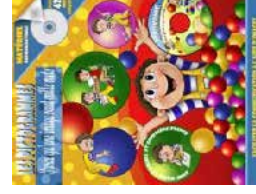

Note: Pictograms pictured above have been illustrated by Anne-Marie Le Gouill. To access a full bank of Anne-Marie's pictograms, seek the following resource: LES PICTOGRAMMES, parce qu'une image vaut mille mots; Anne-Marie Le Gouill et Geneviève Plante. www.lespictogrammes.com

GEOMETRIC SHAPES

scissor Skills



This certificate demonstrates the effort, progress and success of:

for cutting **GEOMETRIC SHAPES**

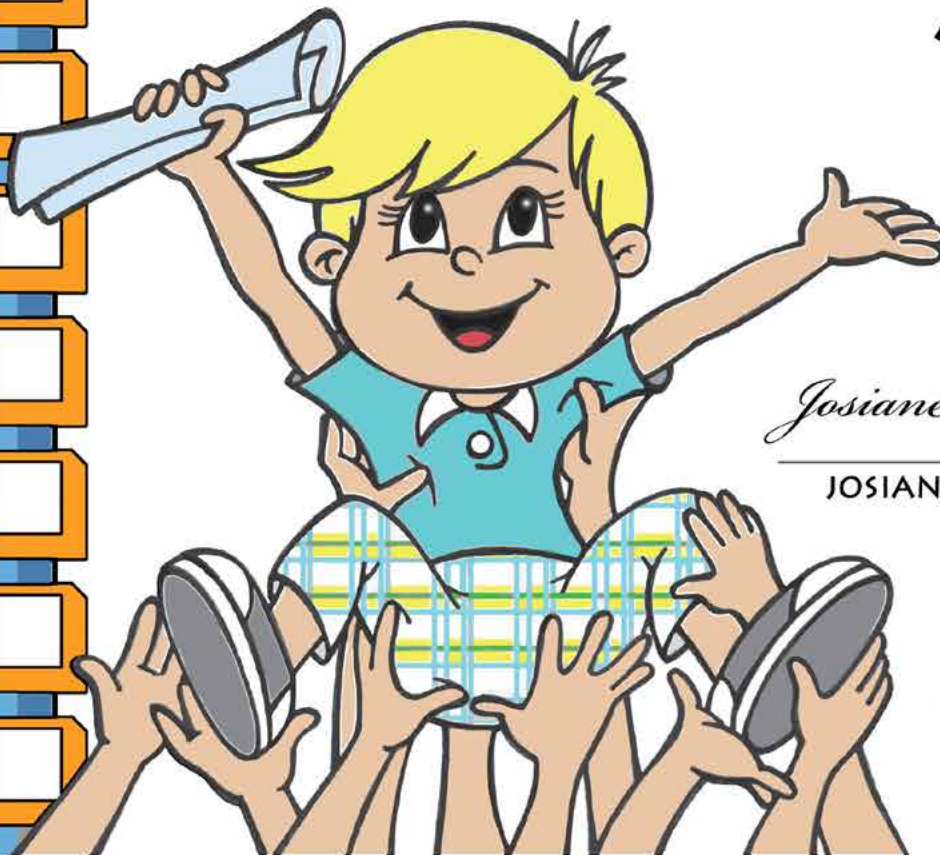
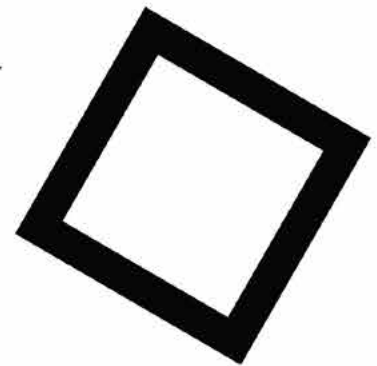

Josiane Caron Santha

JOSIANE CARON SANTHA

Section 2: The Cutting Program

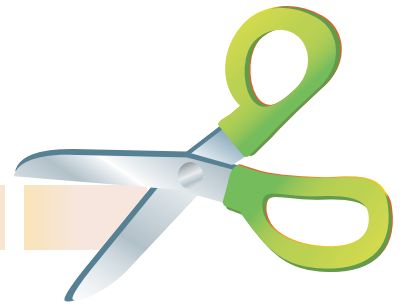

List of Projects

Cutting Straight Lines

1. The Bag of Candy
2. The Birthday Party
3. The Crown
4. The Snowflake
5. The Apple
6. The Hairy Head
7. The Octopus
8. The Sun
9. The Train
10. The Bowl of Fruit
11. Bracelets
12. Garland
13. The Hedgehog
14. The Puzzle

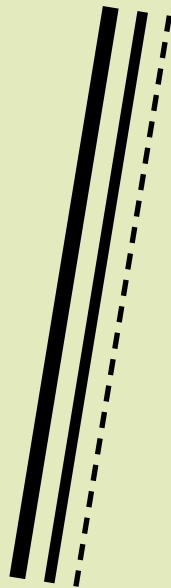

Cutting Curves and Circles

27. The Watermelon
28. The Igloo
29. The Rainbow
30. The Football
31. The Moon
32. The Mother's Day Card
33. Planets
34. The Pizza
35. The Meal
36. The Clock
37. The Snowman
38. Sports Balls
39. The Bear

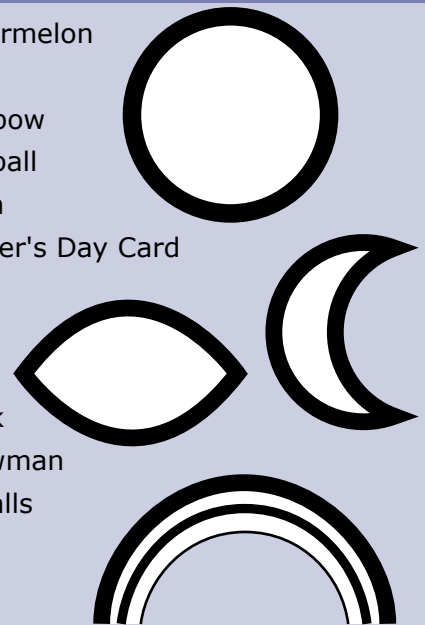

Cutting Geometric Shapes

15. The Stop Sign
16. The Traffic Light
17. The Television
18. The Picture Frame
19. The Kite
20. The Christmas Tree
21. The Piano
22. The Pyramid
23. The Pumpkin
24. The Robot
25. The House
26. The Boat



Cutting Irregular Shapes

40. The Toothbrush and Toothpaste
41. The Beverage
42. The Butterfly
43. The Ice Cream Cone
44. The Car
45. The Bone
46. The Storm
47. Clothes
48. The Flower
49. The Cat
50. Tools

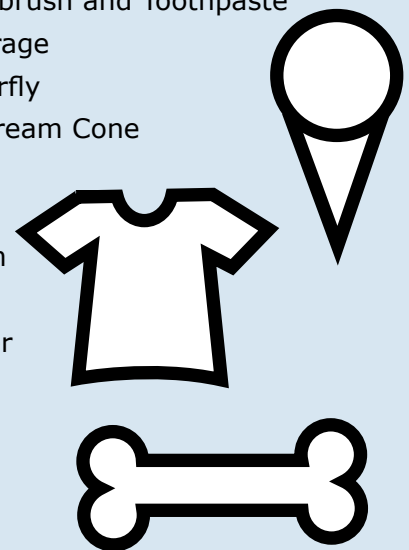

Cutting Straight Lines

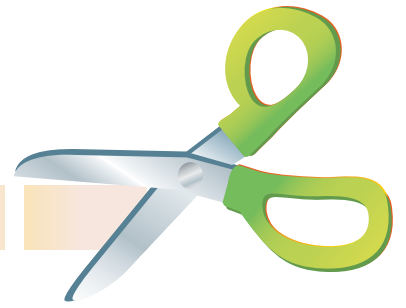

Project 2: The Birthday Party

Materials: Scissors, markers, glue, cardboard (optional).

Version A:

1. Color the picture.

Version B:

1. ***For new learners, an adult pre-cuts the tabs and glues them onto cardboard before handing them back to the child.***
2. Color the gifts.
3. Cut along the black lines.
4. Glue the gifts next to the cake on the table with the help of the guide.
5. (Optional) Color the table and the cake.

Version C:

1. ***For new learners, an adult pre-cuts the tabs and glues them onto cardboard before handing them to the child.***
2. Color the gifts.
3. Cut along the black lines.
4. Glue the gifts next to the cake on the table.
5. (Optional) Color the table and the cake.

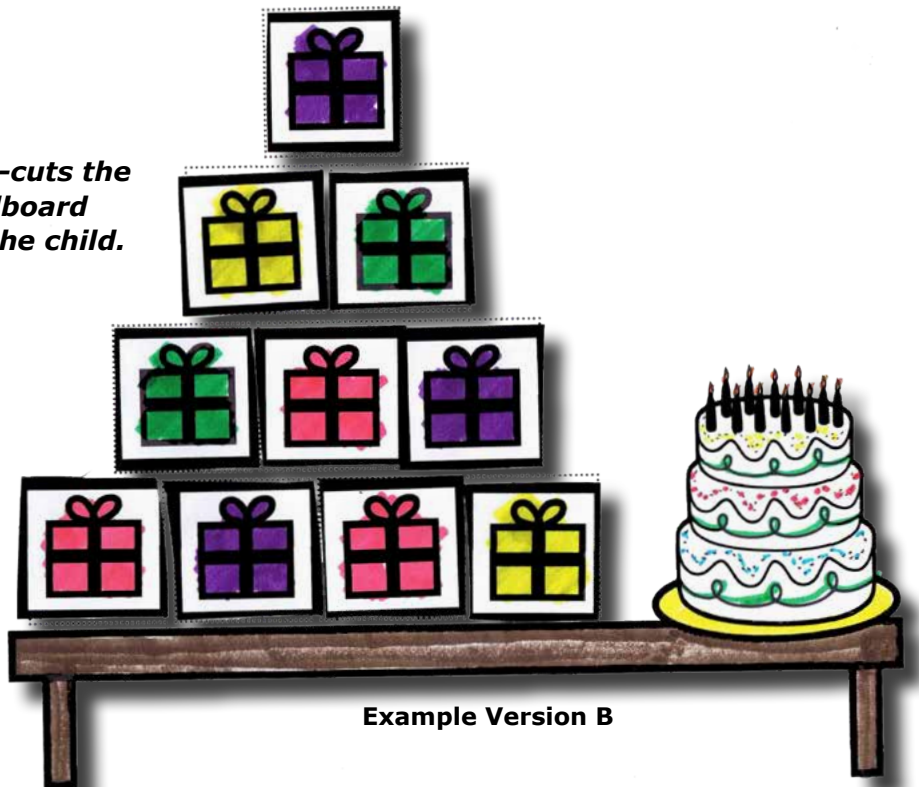

Example Version B



Ideas for Activities:

1. Discuss the connection between one's birthday and their actual day of birth and link them to the concept of time (years).
2. Discuss the process of creating life (love, pregnancy, birth).
3. Look at pictures of a pregnant mother and order the pictures according to the sequence of pregnancy using the size of her stomach as an indicator.
4. Draw a parallel with animals. Discuss the different modes of development and birth depending on the species (egg versus child bearing).
5. Discuss the perspective of others, such as their tastes. Try to determine what might please another (peers or family) if they would buy a birthday present for them.

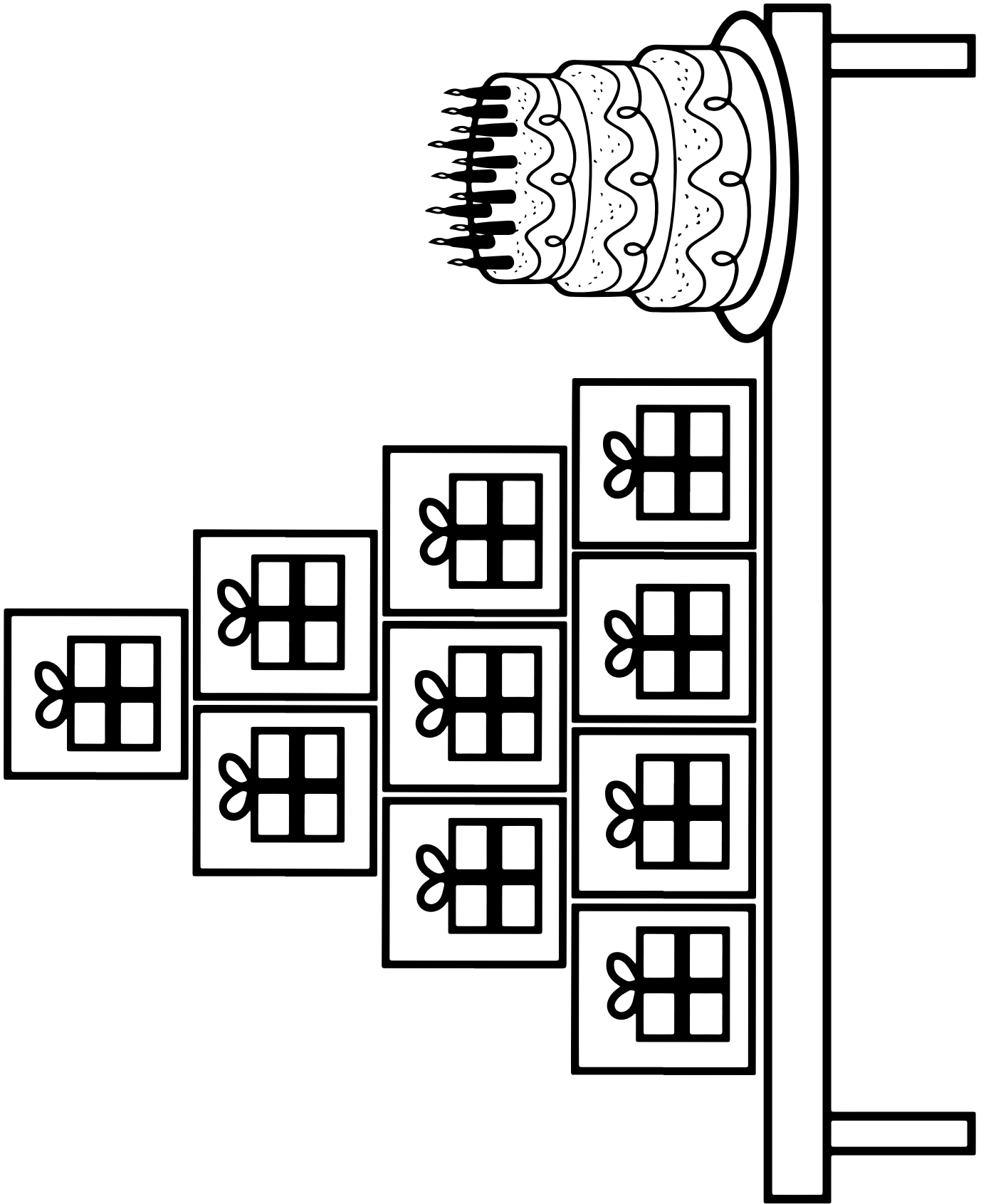

Adult: For new learners, pre-cut outside of tabs and glue them onto cardboard before handing them to the child.



Adult 



Adult 

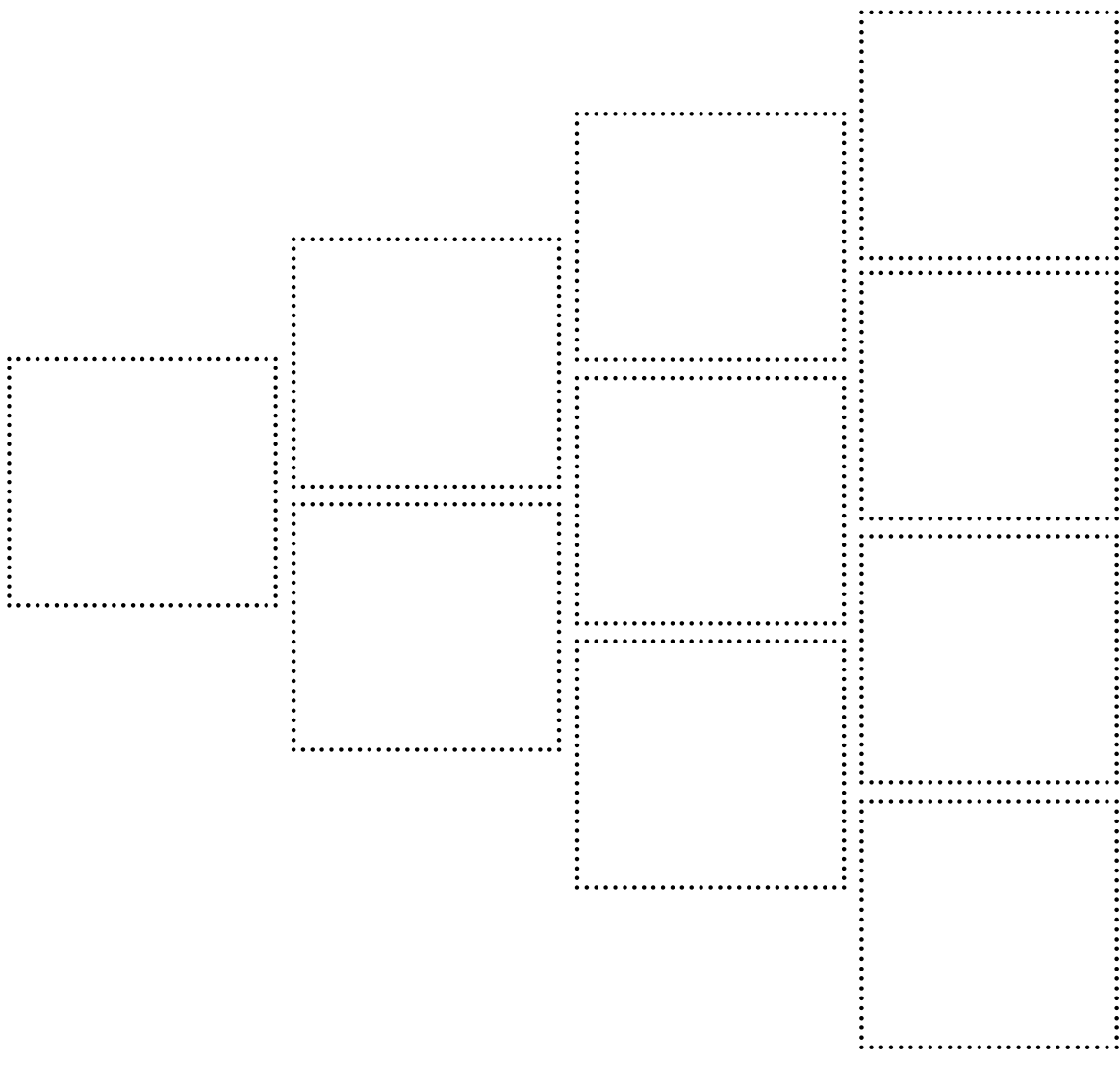
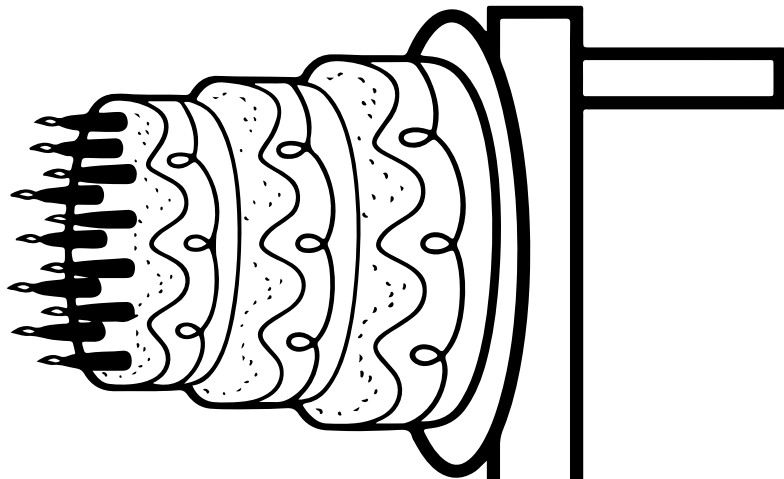

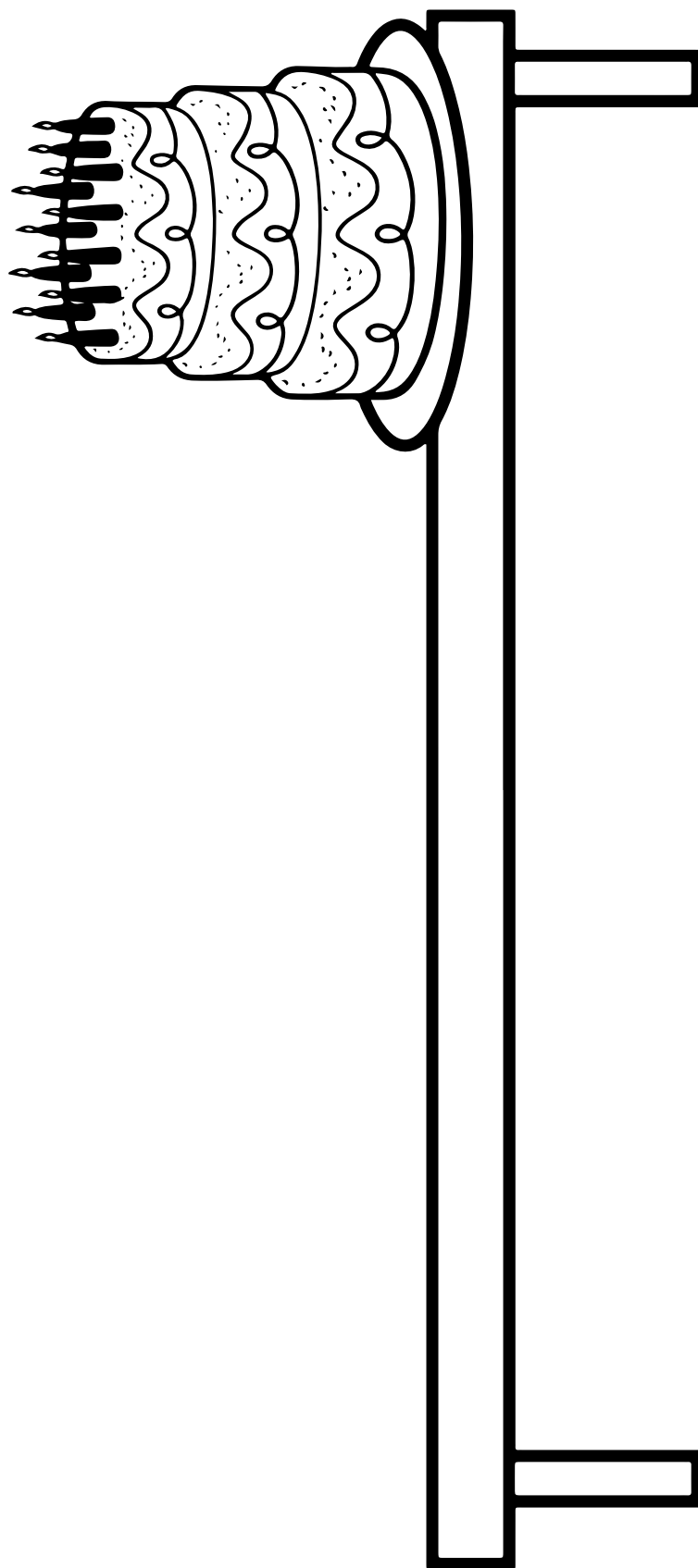

Cutting Geometric Shapes

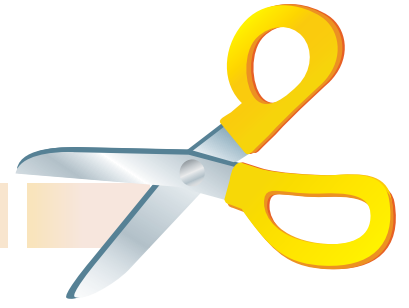

Project 24: The Robot

Materials: Scissors, markers, glue.

Version A:

1. Color the picture.

Version B:

1. Color the robot parts.
2. Cut out the robot parts.
3. Glue the robot on the page at the place designated by the dotted guide.
4. (Optional) Color the rest of the picture.

Version C:

1. Color the robot parts.
2. Cut out the robot parts.
3. Assemble the robot on the planet.
4. Glue the robot on the page.
5. (Optional) Color the rest of the picture.



Example Version C



Ideas for Activities:

1. Invent a dance and have fun dancing and talking like a robot.
2. Discuss the presence of technology in everyday life by identifying electrical or electronic items that make our lives easier.
3. Explain to the child what life was like before technology (electrical devices) existed. (Did you know that when "Grandma" was a little girl there was no television...)

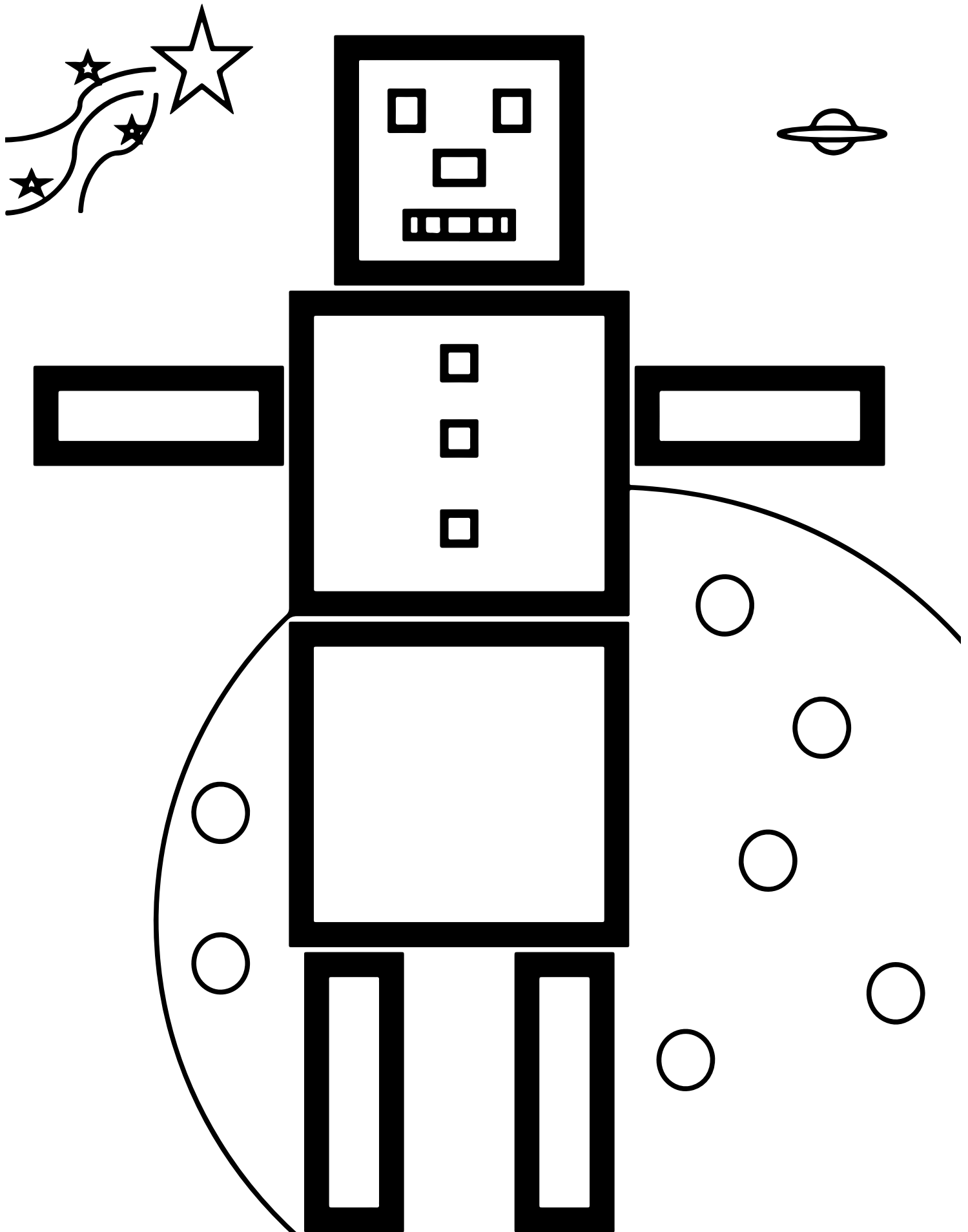

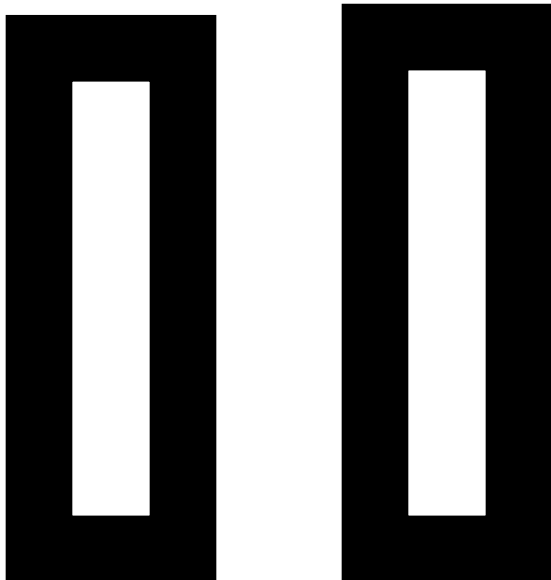
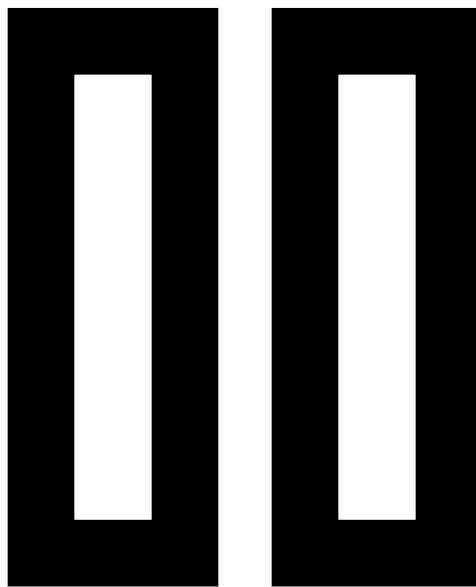
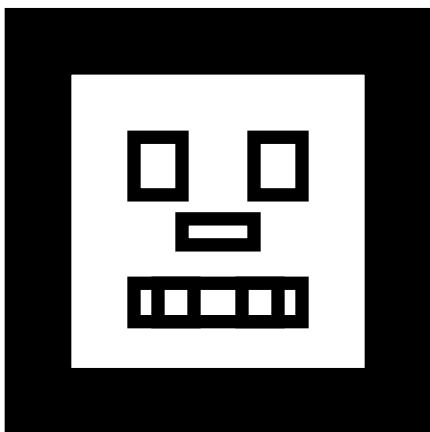
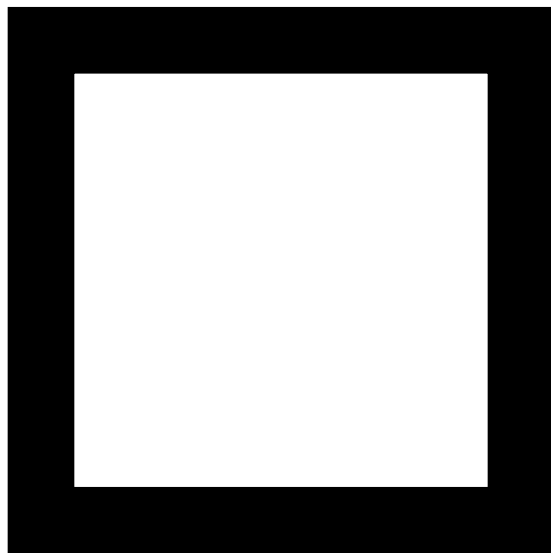
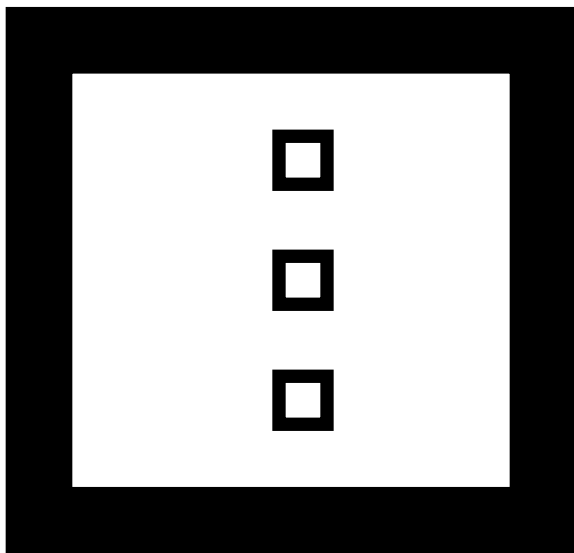

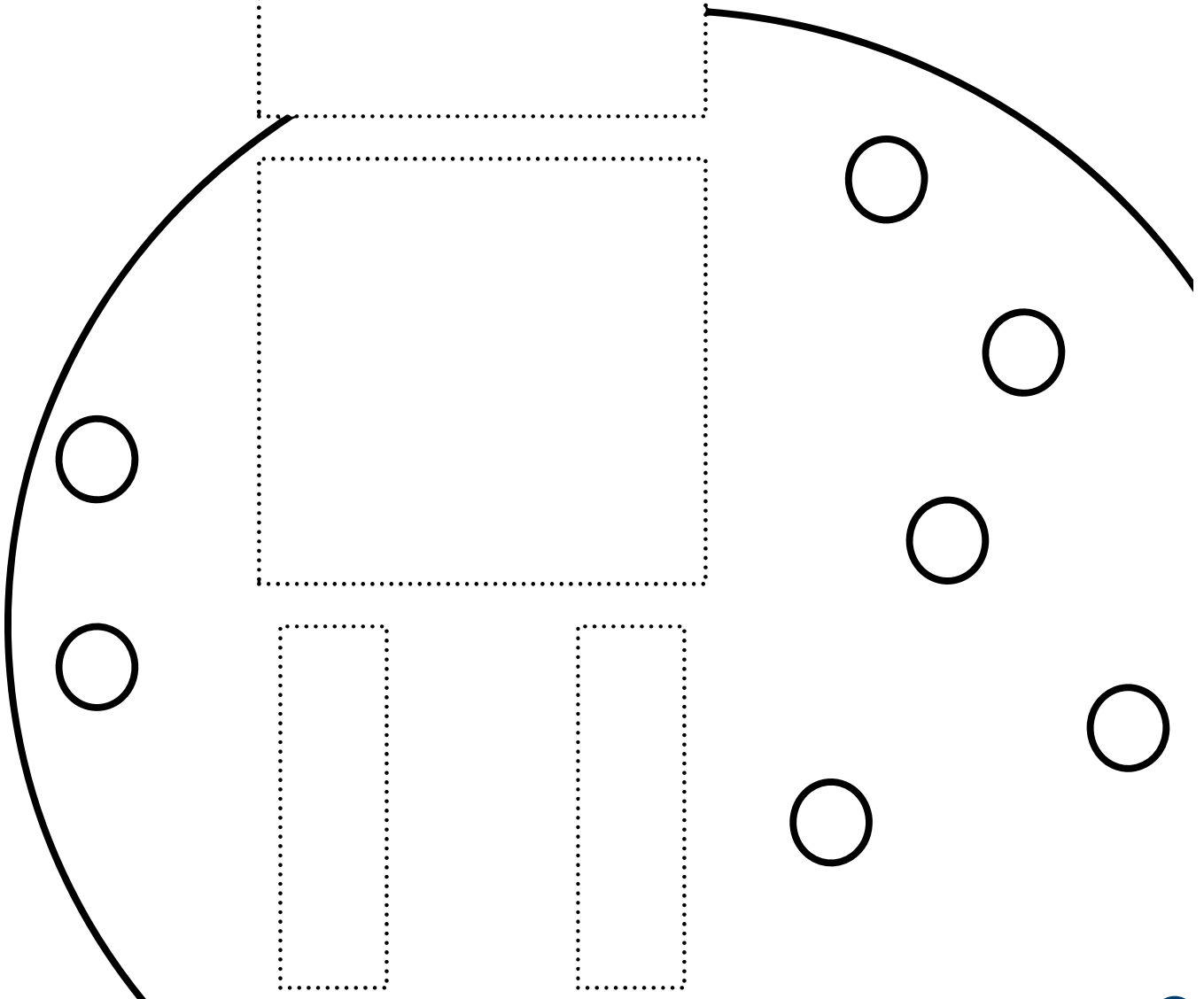
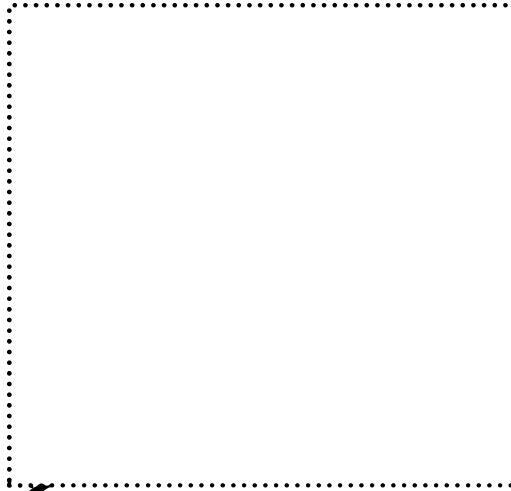
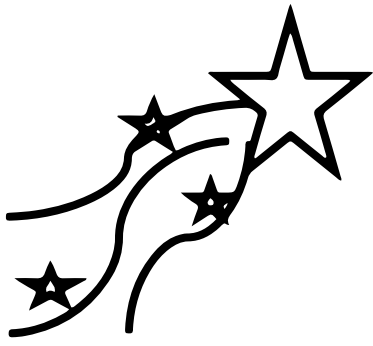

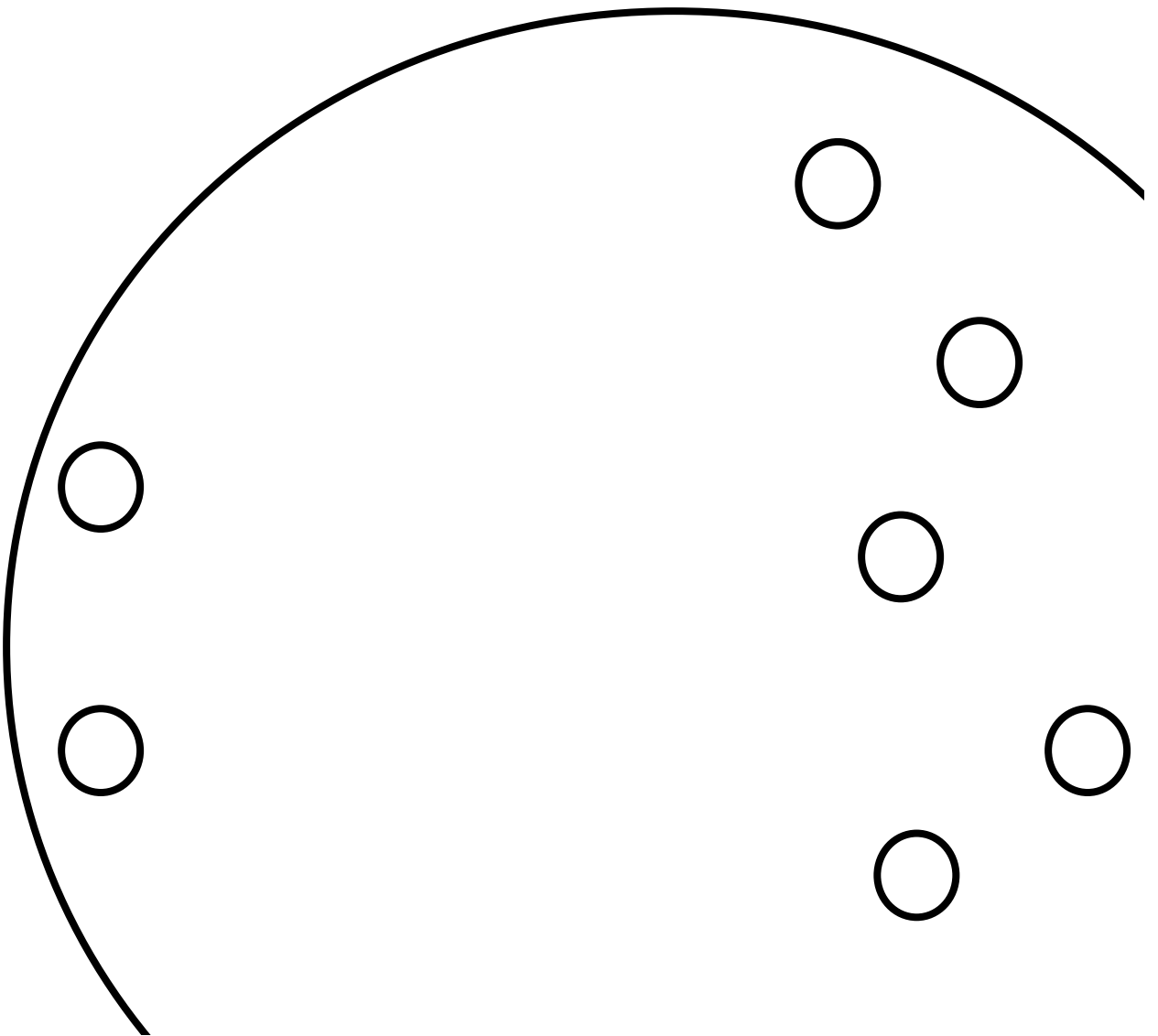
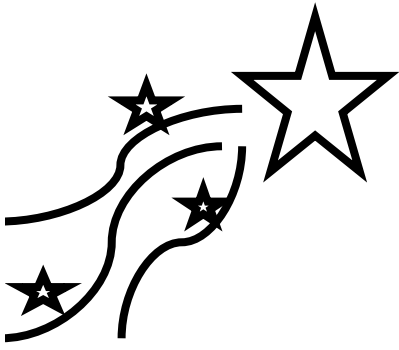

Cutting Curves and Circles

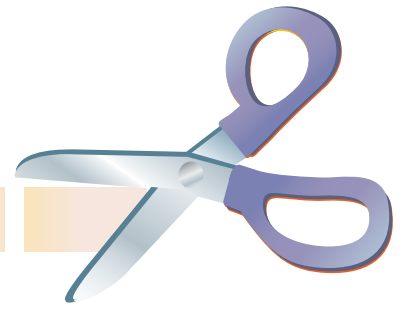

Project 33: Planets

Materials:

Scissors, markers, glue.

Version A:

1. Color the planets.

Version B:

1. Color the planets.
2. Cut out the planets.
3. Glue the planets in the spaces near the other planets using the dotted guide.
4. Color the rest of the picture.

Version C:

1. Color the planets.
2. Cut out the planets.
3. Glue the planets in the spaces near the other planets and stars.
4. Draw and decorate the other planets.
5. Color the picture.



Example Version B



Ideas for Activities:

1. If available, show the child a globe or a world map and discuss with them the various places where they have been and where people live (countries). Let them point to different countries and teach them the name of the country. Show the child where they live.
2. Talk about the physical differences (eye shape, skin color, etc.) and cultural differences between people of different origins.

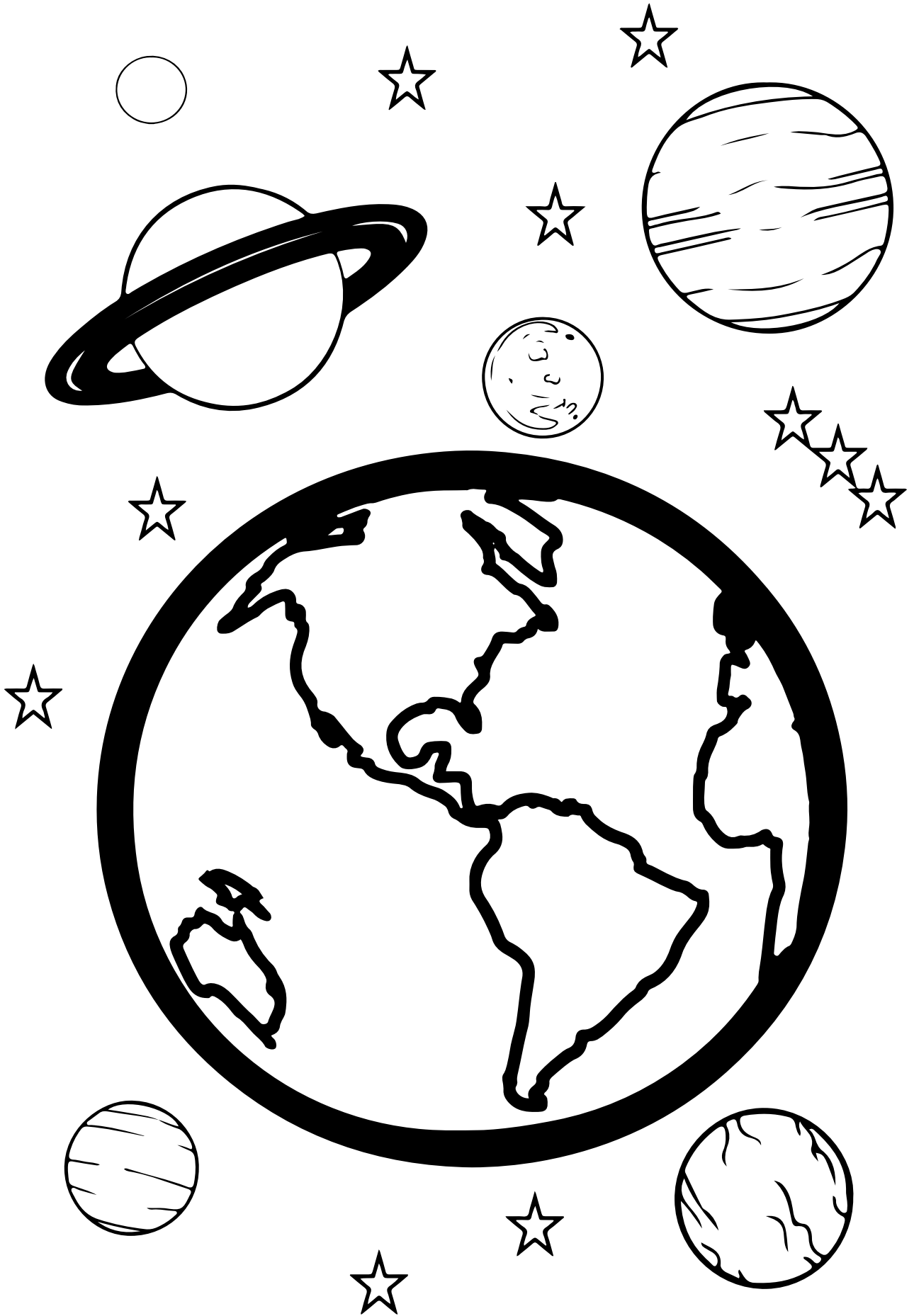

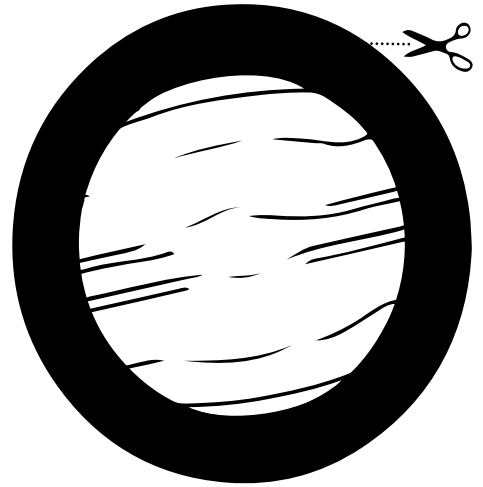
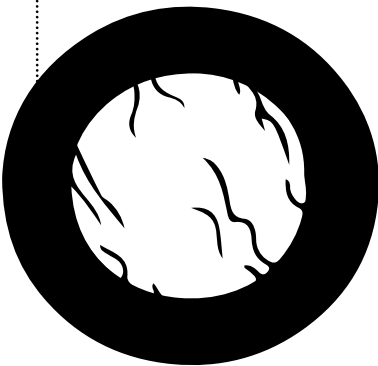

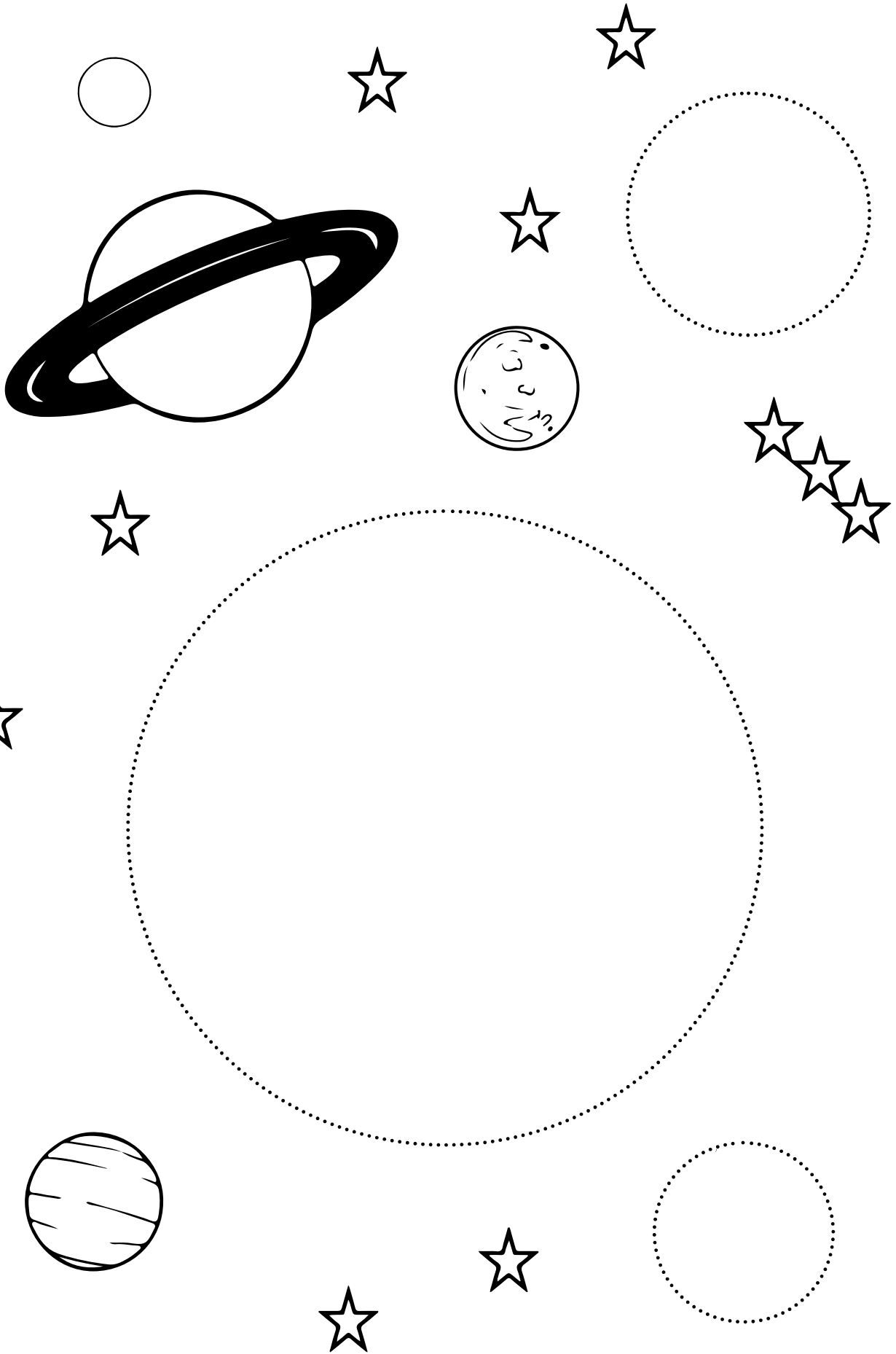

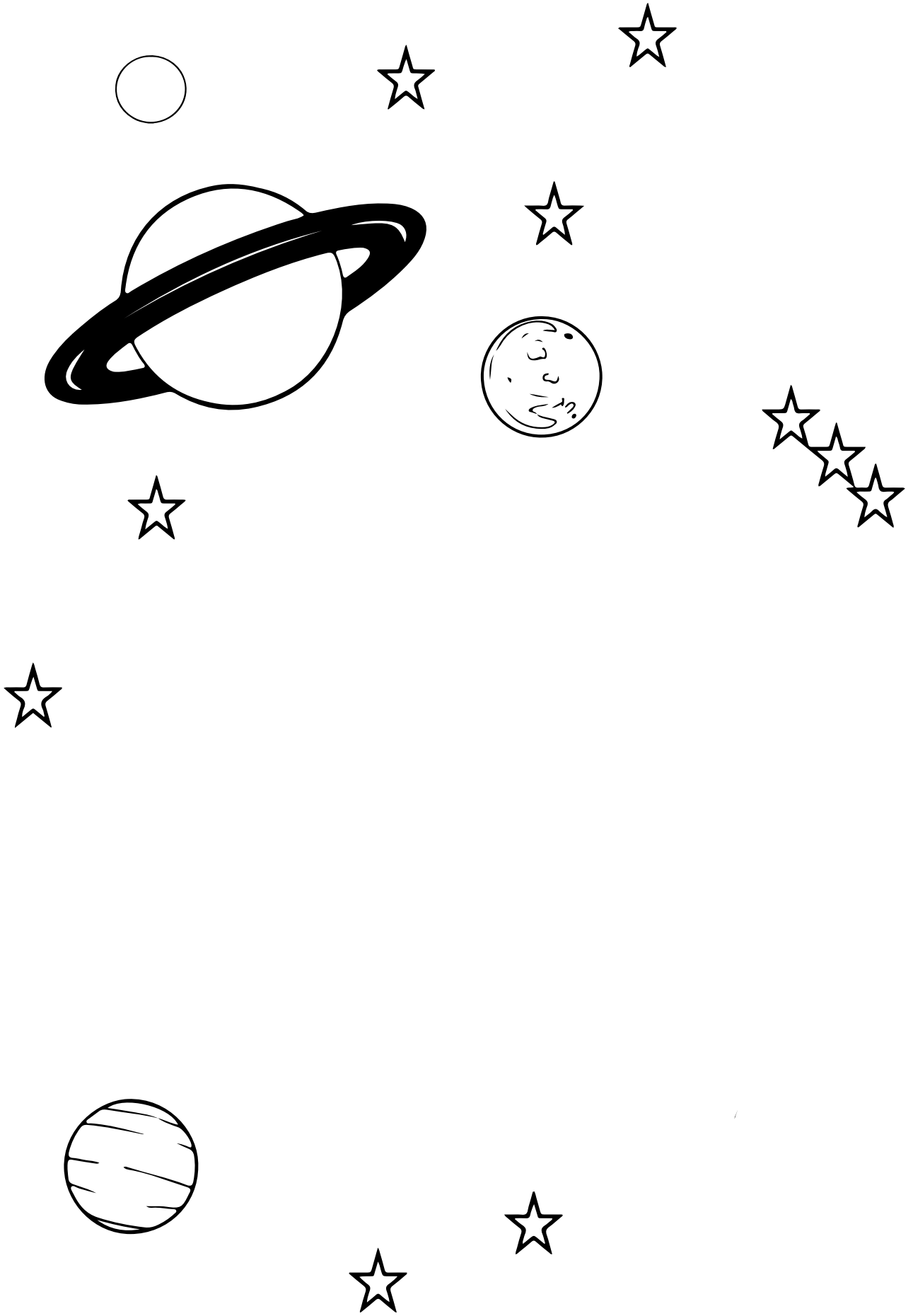

Cutting Irregular Shapes

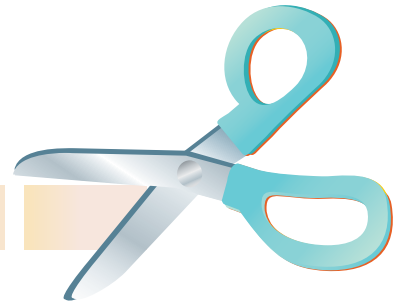

Project 42: The Butterfly

Materials: Scissors, markers, glue.

Version A:

1. Color the picture.

Version B:

1. Color the butterfly wings.
2. Cut out the butterfly wings.
3. Glue the wings on the butterfly as indicated by the dotted guide.
4. (Optional) Color the rest of the picture.

Version C:

1. Decorate and color the butterfly wings.
2. Cut out the butterfly wings.
3. Glue the wings on the butterfly as indicated by the dotted guide.
4. (Optional) Color the rest of the picture.



Example Version B



Ideas for Activities:

1. Discuss the transformation from caterpillar to butterfly.
2. Role play by pretending to be a caterpillar. Make a cocoon with blankets and later turn into a butterfly.

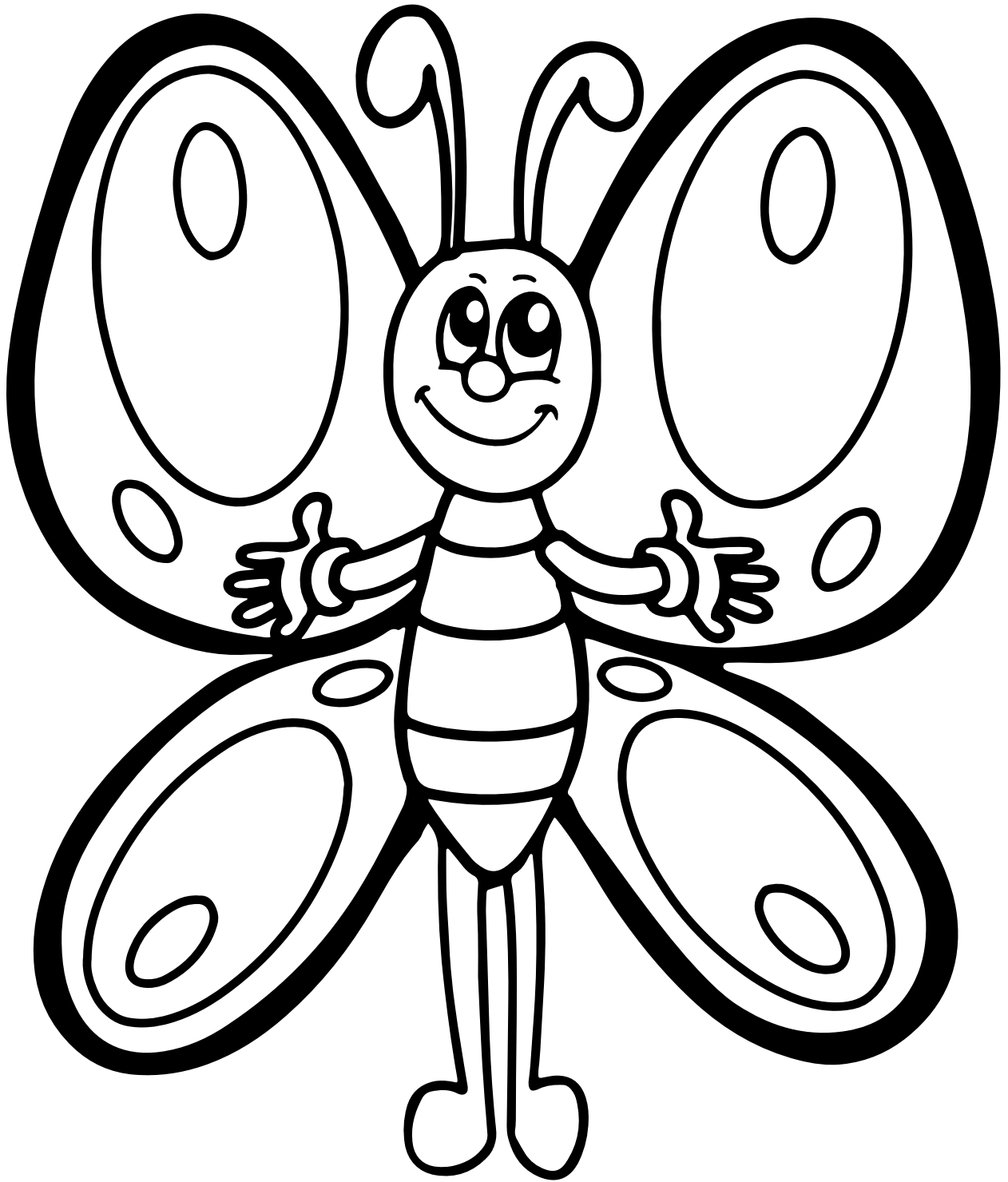

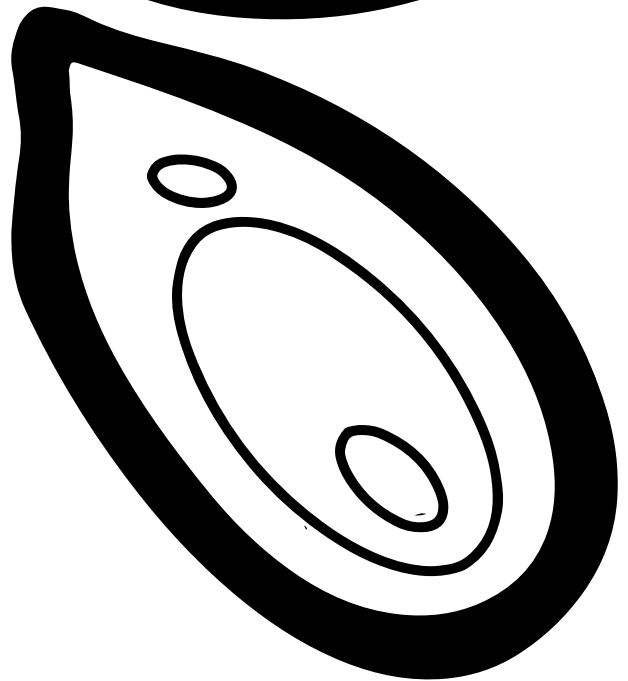
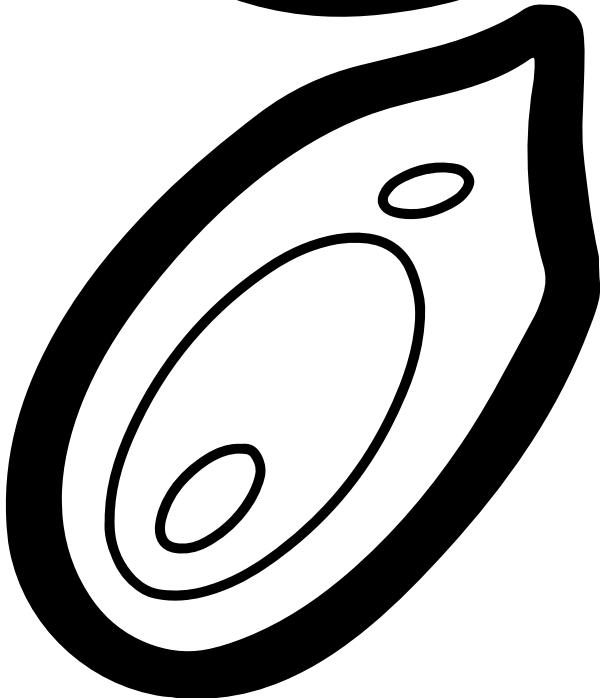
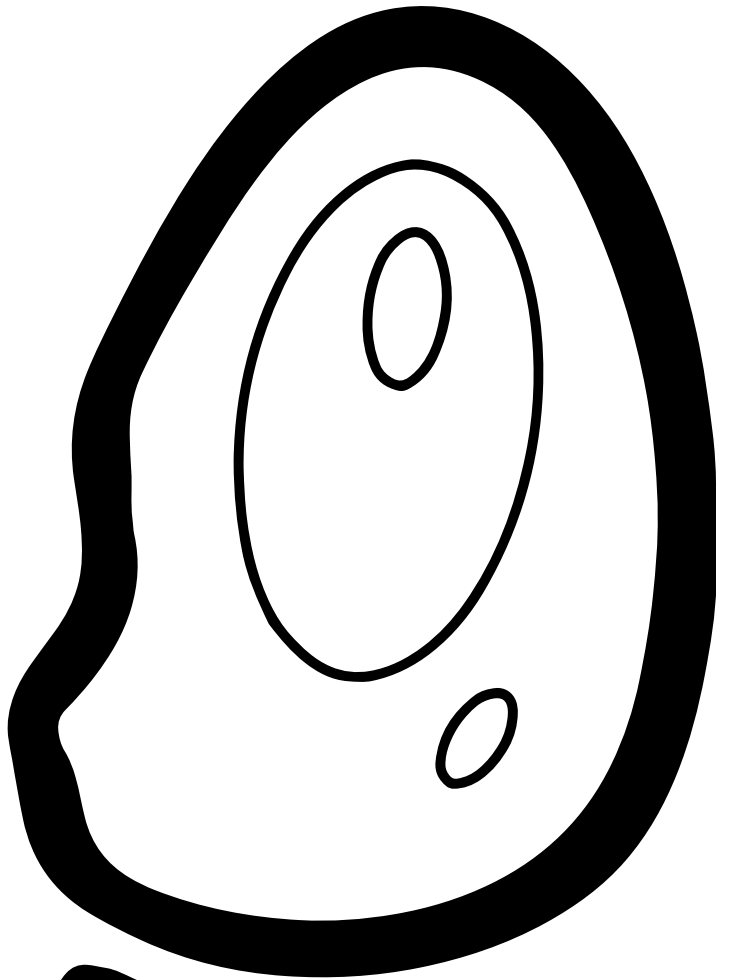
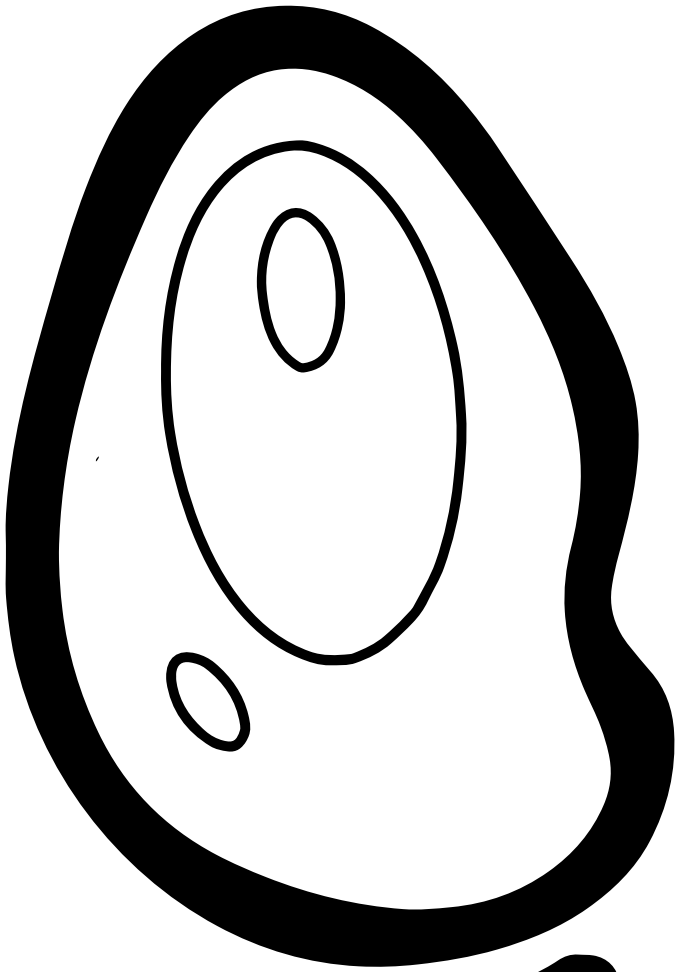

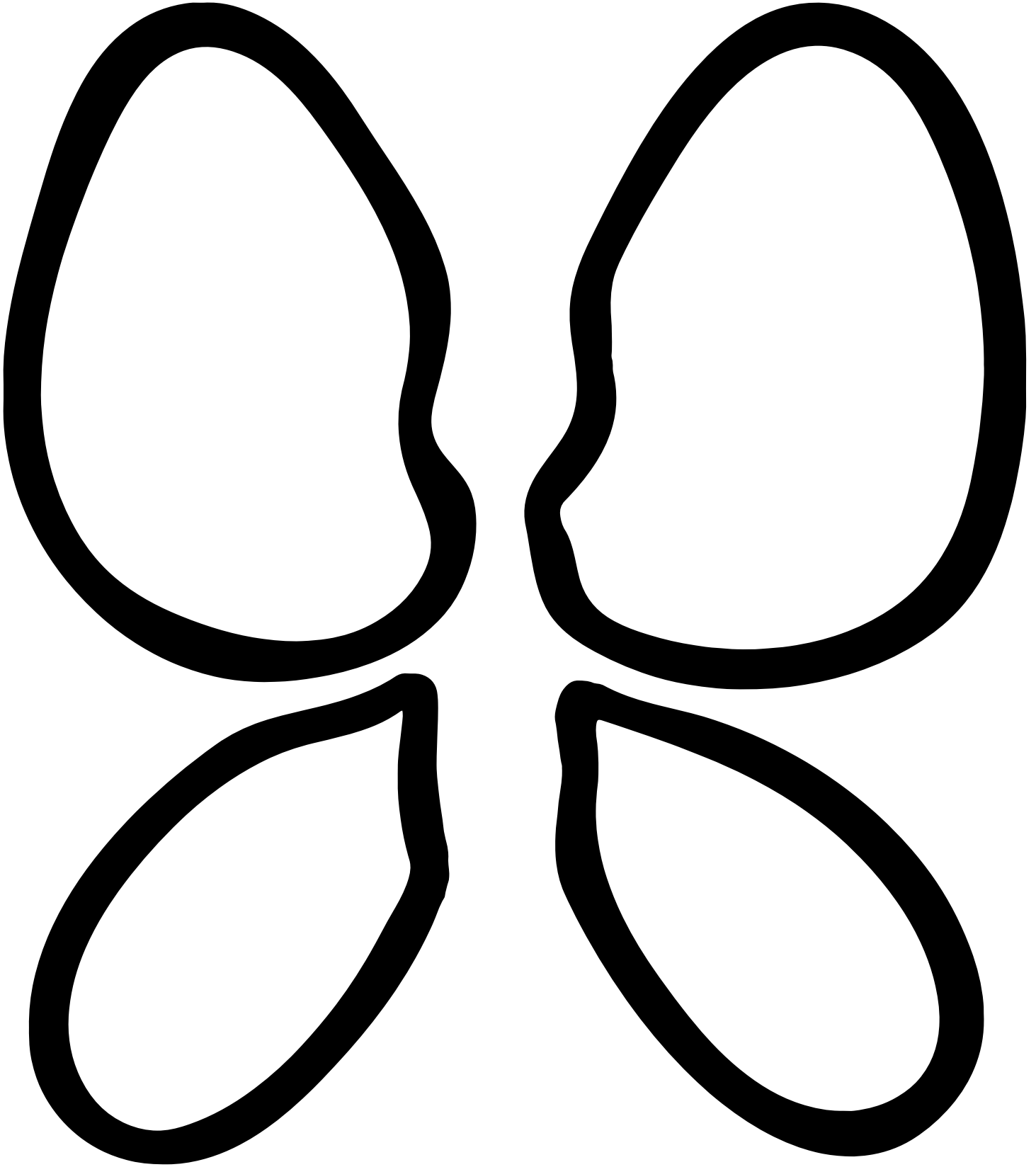

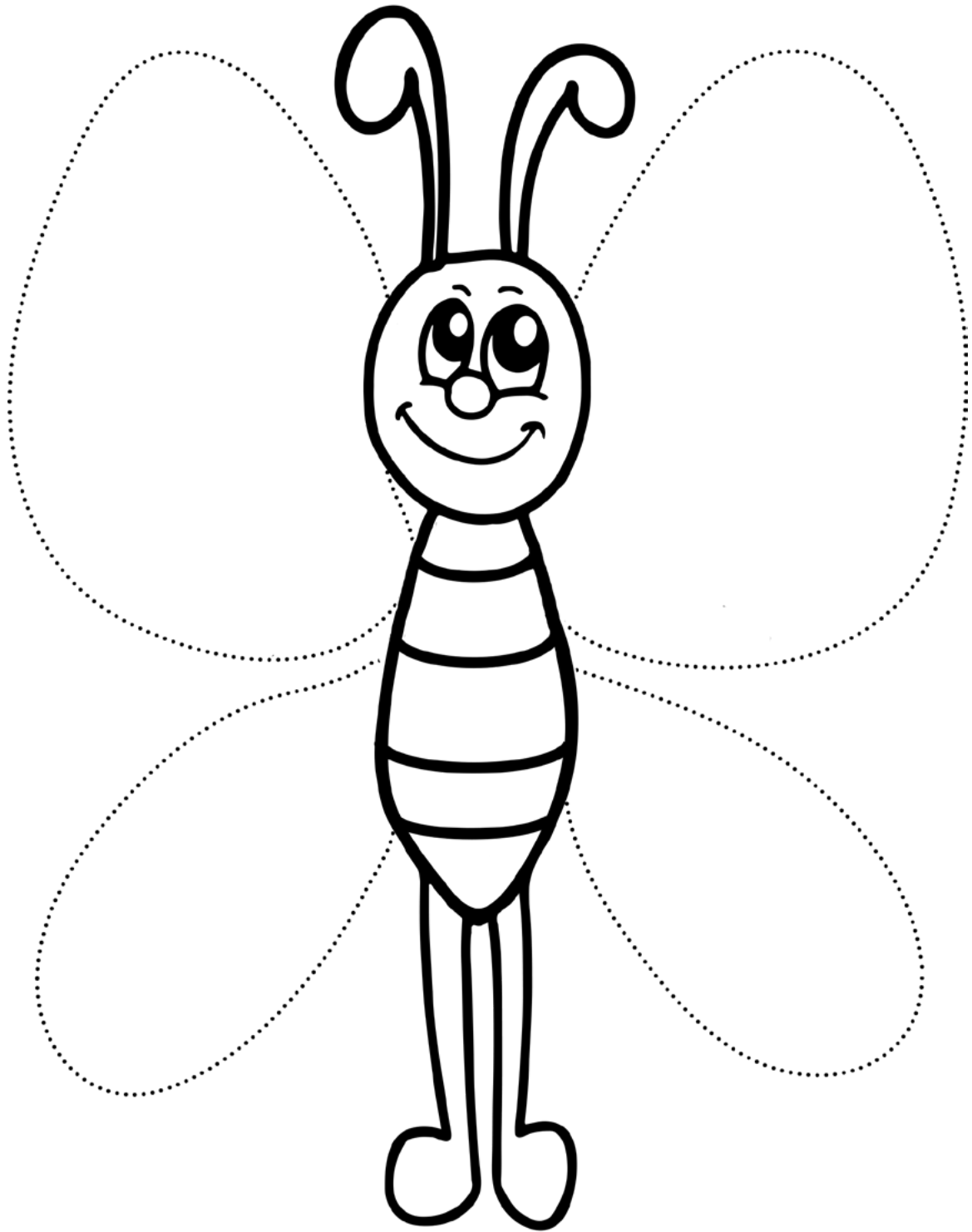

The Scissor Skills Sourcebook

A comprehensive and sequential approach for all

Allowing any child to develop their cutting skills comes down to offering them **appropriate challenges based on their abilities**. With each individual success, the child will continue to be interested in cutting and highly motivated to improve their skills.

This book is for everyone who has the opportunity to help children with their motor and creative development (**parents, educators, teachers, therapists**). **50 projects are offered**, each one more challenging than the last, in sync with the natural development of a child. It teaches skills required to start cutting and takes the child all the way to cutting complex shapes. The Scissor Skills Sourcebook is designed to grow with the child. Useful starting at **2½** years old, this training resource is useful for education purposes up to and including **7** years of age. After proper cutting skills have been achieved, these fun projects can continually be enjoyed at all ages!

Each project can be done at **different levels of difficulty** (versions), the simplest involving only coloring and no cutting. This unique aspect meets the needs of multi-age environments and allows the child to enjoy the same project at different times throughout their childhood (e.g., coloring at 2 years old, cutting at 4 years old, drawing and building at 6 years old.) With a project suited to their own abilities, success is guaranteed for the child.



All the **projects are simple and quickly achieved** requiring only every day materials such as scissors, glue and markers. In order to properly complete a period of activity, both at home and in childcare, activities related to themes of the cutting projects are provided. From shapes to plants to concepts of time, **educational and fun ideas abound**.

To meet all needs, this tool is enriched with **theory** on the development of cutting skills and practical advice to support the child who progresses more slowly as well as **printable tools and observation and monitoring checklists** for specialists.

Josiane Caron Santha, MSc. has been an Occupational Therapist since 1998. Josiane is the owner of Les Mille-Pattes, a pediatric OT clinic renowned for its services in occupational therapy with autism. Columnist for multiple online publications, Josiane is also a mother of two children, an author and a lecturer. As a result of these experiences, she has become familiar with the needs of parents, daycare workers and specialists, all of which inspired this project.

